

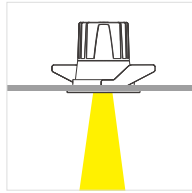

CORA
SQUARE

ARKLED



Fixed

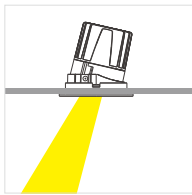

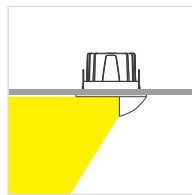

Adjustable



Wall Washer

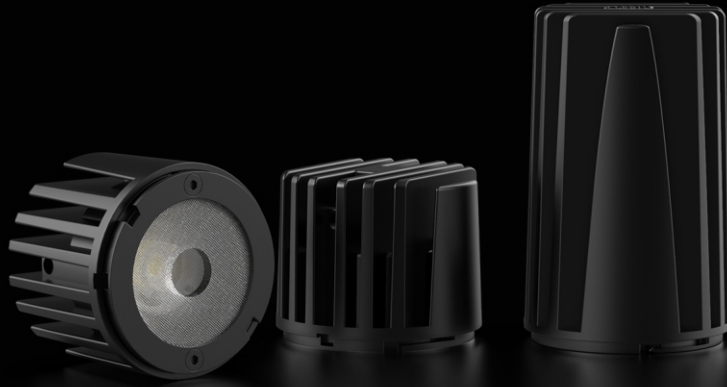



NO	ITEM CODE	POWER	INPUT	ANGLE	CRI	CCT	IP
MD03-1		3W	DC700mA 3V	4°	Ra≥90	2700K/3000K/ 3500K/4000K	IP20
MD06-1		6W	DC1500mA 3V	6°	Ra≥95	2700K/3000K/ 3500K/4000K	IP20
MD10-1		10W	DC700mA 12V	8°	Ra≥90	2700K/3000K/ 3500K/4000K	IP20
MD06-C		6W	DC150mA 36V	15°/24°/36°/50°	Ra≥95	2700K/3000K/ 3500K/4000K	IP20/IP54
MD10-C		10W	DC250mA 36V	15°/24°/36°/50°	Ra≥95	2700K/3000K/ 3500K/4000K	IP20/IP54
MD15-C		15W	DC350mA 36V	15°/24°/36°/50°	Ra≥95	2700K/3000K/ 3500K/4000K	IP20/IP54
MD10-H		2-10W Tunable White	DC250mA 36V	15°/24°/36°/50°	Ra≥90	2800K-6000K	IP20



MD10-H

Power: 2-10W

Input: 40-250mA

CCT: 2800K-6000K

Angle: 15°/24°/36°/50°

Dimmable Control

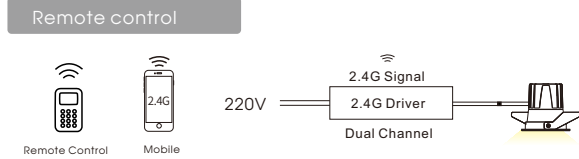
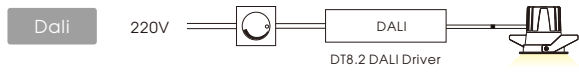
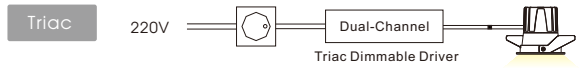

Low color temperature and low illumination



Low color temperature and high illumination



High color temperature and low illumination



High color temperature and high illumination

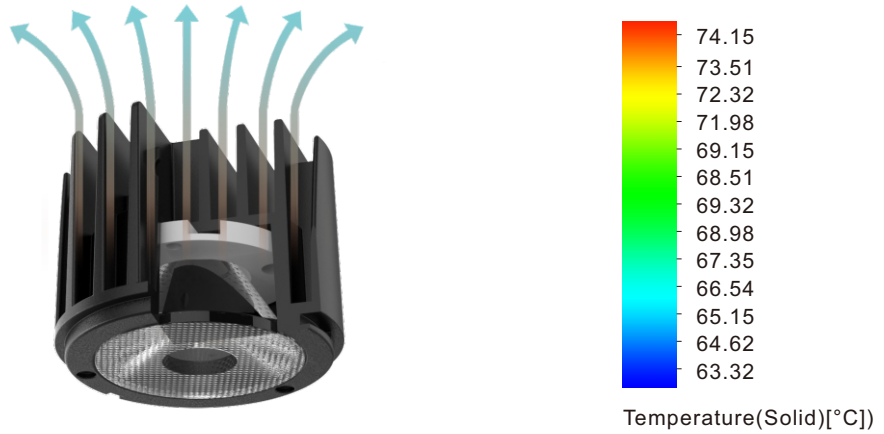

Thermal Management

The lifetime of LED is not only determined by its quality, but also affected by the thermal management. Especially for LED luminaires, only perfect thermal management can ensure the lifetime. If the heat cannot spread out quickly, the lifetime of LED will be seriously affected. The self-developed high-performance heatsink structure ensures that the LED light source can dissipate heat rapidly, and the chip temperature is lower than the working temperature defined by the light source manufacturer, which really guarantees the lifetime of LED.

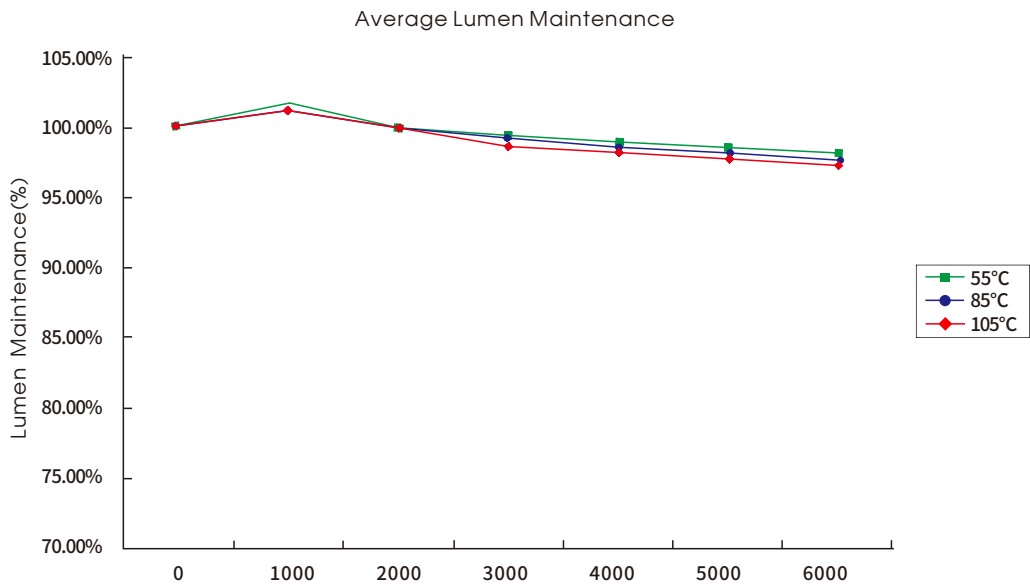

CRI COLOR METRICS(Values are typical)

COLOR Maintenance :
 ENERGY STAR LIMIT ≤ 0.007
 LM-80 6000hour Chromaticity Shift ($\Delta u'v'$) 0.0023

COB LED
 CRI>95



CRI95 TM-30 COLOR METRICS	
Rf	94
Rg	103
CCT	3000K
CIE Ra	97

R1	R2	R3	R4	R5	R6	R7	R8	R9	R10	R11	R12	R13	R14	R15
98	99	97	98	98	97	99	99	98	99	96	87	98	97	98

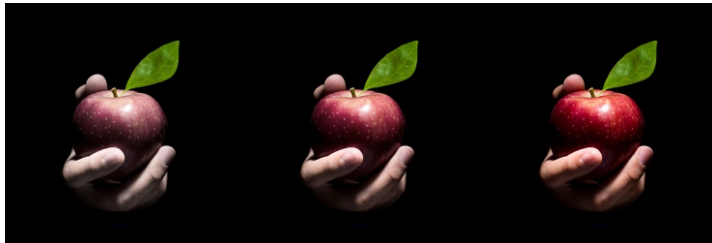

Ra80

Ra90

Ra95

CRI97 3000K COLOR RENDITION BY HUE ANGLE

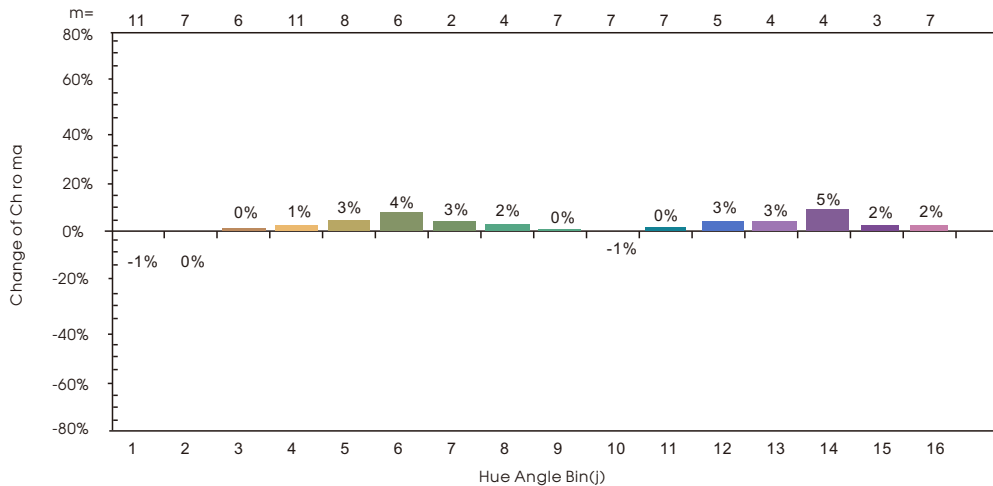

Radiate smooth spectrum from blackbody radiation curve, natural and mild, appropriate visual red effect. In addition, the standard series is also superior to the ceramic metal halide lamp and fluorescent lamp in terms of lighting quality, sustainability, efficiency and life, and superior to the competitors in terms of visual perception and consistency.



Optical Filters

Matching with different optical filters, not only can realize the angle change, but also can realize the facula shape change.

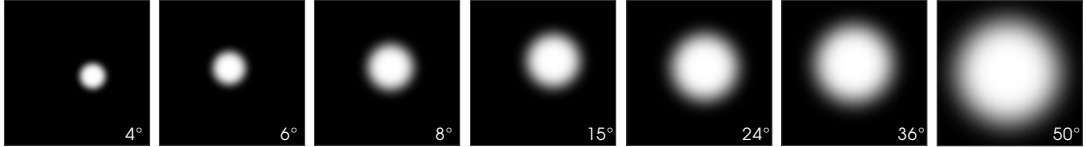

Optional Accessories



LED Module



LED Module + Woven Glass



Honeycomb

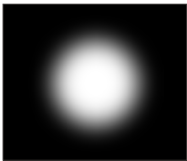

LED Module



LED Module+Combed Glass



Woven Glass

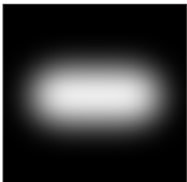

Combed Glass + LED Module = Effect



Combed Glass

UGR \leq 3.5

57 degree degree cut -off angle and
concave LED module are used
to be anti-glare and achieve uniform light

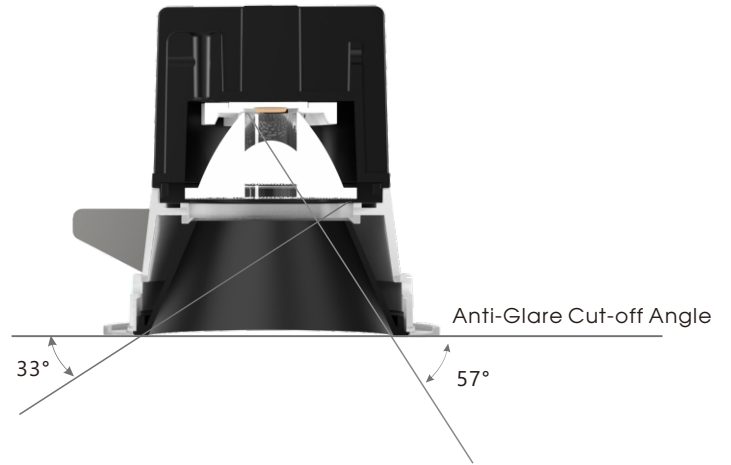

Cora recessed down light is featured with thousands of combination possibilities: 3W/6W/10W/15W LED module, fixed or adjustable, round or square, for direct lighting or wall washing. Cora are available in a choice of beam angles: super narrow 4°/6°/8°degrees for long distance light transmission, standard 15°/24°/36°/50°degrees, and special asymmetric wall washer lens for wall washing. With DARLIGHT design support, Cora provides a high level of comfortable visual and optimum light output ratio.



Product profile

Item Code	Input	Luminous Flux	Lamp	Beam Angle	Available Dimming
DSA2103-1	DC700mA 1x3W	130lm	CREE	4°	
DSA2106-1	DC150mA 1x6W	480lm	Luminus	6°	
DSA2110-1	DC700mA 1x10W	960lm	CREE	8°	
DSA2106-C	DC150mA 1x6W	414lm	HonourTEK	15°/24°/36°/50°	Triac/Dali/0-10V
DSA2110-C	DC250mA 1x10W	860lm	HonourTEK	15°/24°/36°/50°	Triac/Dali/0-10V
DSA2115-C	DC350mA 1x15W	1344lm	HonourTEK	15°/24°/36°/50°	Triac/Dali/0-10V
DSA2110-H	DC250mA 1x10W	860lm	TYANSHINE	15°/24°/36°/50°	

Size

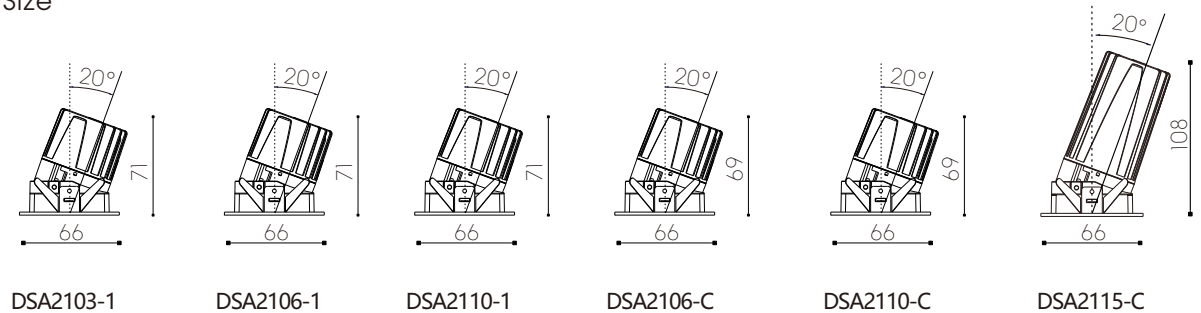



DSA2103-1

0.19 60x60 III ▼ CE IP20

Material	Input	Luminous Flux	CRI	Lamp
Aluminum	DC700mA 1x3W	130lm/3000K	$R_a \geq 90$	CREE XPE

Color : White Black

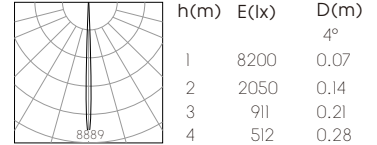
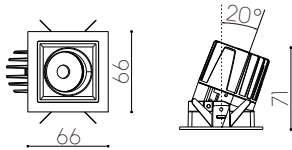

DSA2106-1

0.19 60x60 III ▼ CE IP20

Material	Input	Luminous Flux	CRI	Lamp
Aluminum	DC150mA 1x6W	480lm/3000K	$R_a \geq 95$	Luminus SST20

Color : White Black

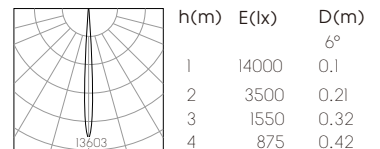
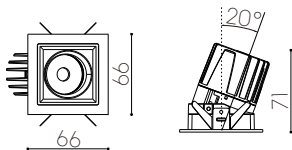

Optional Colors for Baffle

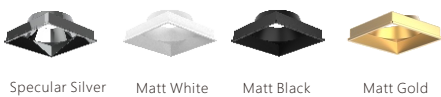

Specular Silver

Matt White

Matt Black

Matt Gold

Optional Accessories



Honeycomb
Size: $\phi 33 \times 3$

Combed Glass
Size: $\phi 33 \times 3$

Woven Glass
Size: $\phi 33 \times 3$



DSA2110-1

0.19 50x60 III ▼ CE IP20

Material	Input	Luminous Flux	CRI	Lamp
Aluminum	DC700mA 1x10W	960lm/3000K	$R_a \geq 90$	XHP35

Color : White Black

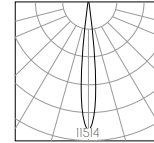
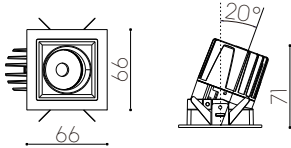

h(m)	E(lx)	D(m)
		8°
1	13600	0.14
2	3400	0.28
3	1510	0.42
4	850	0.56



DSA2106-C

0.19 50x60 III ▼ CE IP20

Material	Input	Luminous Flux	CRI	Lamp
Aluminum	DC150mA 1x6W	414lm/3000K	$R_a \geq 95$	HonourTEK HRB0604

Color : White Black

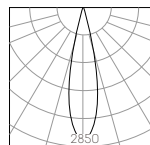
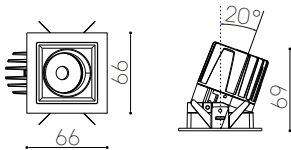

h(m)	E(lx)	D(m)
		15°
1	2042	0.33
2	510	0.66
3	227	0.99
4	128	1.32

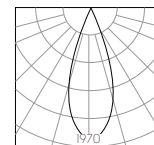

h(m)	E(lx)	D(m)
		24°
1	1386	0.46
2	347	0.92
3	154	1.38
4	87	1.84

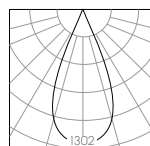

h(m)	E(lx)	D(m)
		36°
1	940	0.62
2	235	1.24
3	104	1.86
4	59	2.50

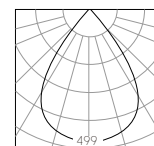

h(m)	E(lx)	D(m)
		50°
1	332	1.00
2	83	2.00
3	37	3.00
4	21	4.00

Optional Colors for Reflector

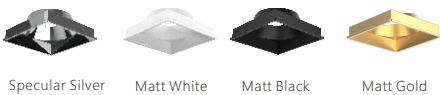

Specular Silver

Matt White

Matt Black

Matt Gold

Optional Accessories



Honeycomb
Size: $\phi 33 \times 3$

Combed Glass
Size: $\phi 33 \times 3$

Woven Glass
Size: $\phi 33 \times 3$

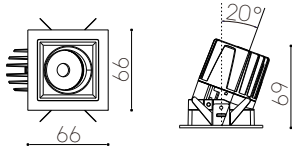

DSA2110-C

0.19 60x60 III V CE IP20

Material	Input	Luminous Flux	CRI	Lamp
Aluminum	DC250mA lx10W	860lm/3000K	$R_a \geq 95$	HonourTEK HRB0607

Color : White Black

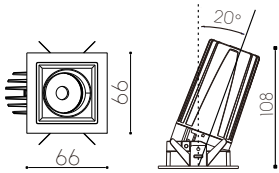
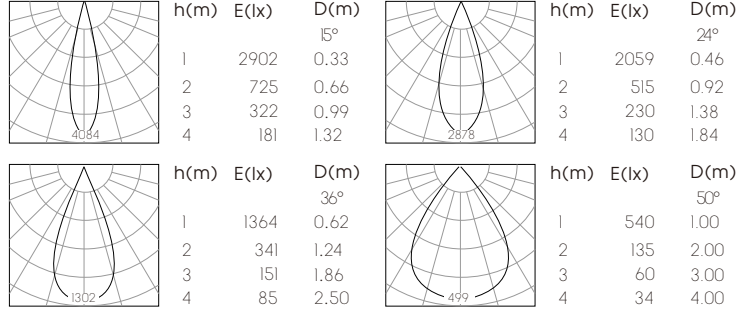

DSA2115-C

0.23 60x60 III V CE IP20

Material	Input	Luminous Flux	CRI	Lamp
Aluminum	DC350mA lx15W	1344lm/3000K	$R_a \geq 95$	HonourTEK HRB0613

Color : White Black

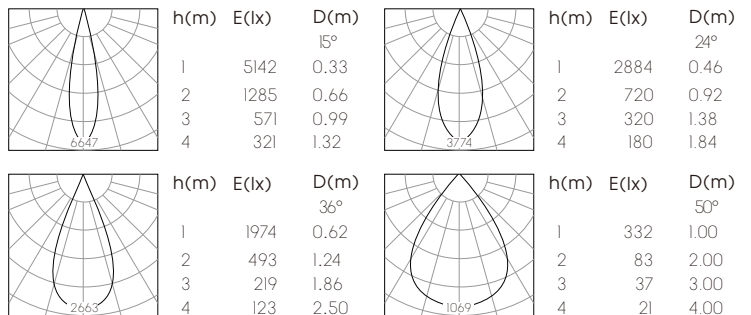

Optional Colors for Baffle



Specular Silver

Matt White

Matt Black

Matt Gold

Optional Accessories



Honeycomb
Size: $\phi 33 \times 3$

Combed Glass
Size: $\phi 33 \times 3$

Woven Glass
Size: $\phi 33 \times 3$



DSA2110-H

Material	Input	Luminous Flux	CRI	Lamp
Aluminum	DC250mA 1x10W	860lm/3000K	$R_a \geq 90$	TYANSHINE

2800k-6500k 2.4G 2-10W

Color : White Black

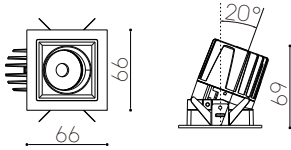

	h(m)	E(lx)	D(m)		h(m)	E(lx)	D(m)
			15°				24°
	1	2902	0.33		1	2059	0.46
	2	725	0.66		2	515	0.92
	3	322	0.99		3	230	1.38
	4	181	1.32	4	130	1.84	
			36°				50°
	1	1364	0.62		1	540	1.00
	2	341	1.24		2	135	2.00
	3	151	1.86		3	60	3.00
	4	85	2.50	4	34	4.00	

Optional Colors for Reflector



Specular Silver

Matt White

Matt Black

Matt Gold

Optional Accessories



Honeycomb
Size: $\phi 33 \times 3$

Combed Glass
Size: $\phi 33 \times 3$

Woven Glass
Size: $\phi 33 \times 3$

Cora recessed down light is featured with thousands of combination possibilities: 3W/6W/10W/15W LED module, fixed or adjustable, round or square, for direct lighting or wall washing. Cora are available in a choice of beam angles: super narrow 4°/6°/8°degrees for long distance light transmission, standard 15°/24°/36°/50°degrees, and special asymmetric wall washer lens for wall washing. With DARLIGHT design support, Cora provides a high level of comfortable visual and optimum light output ratio.



Product profile

Item Code	Input	Luminous Flux	Lamp	Beam Angle	Available Dimming
DSB2003-1	DC700mA 1x3W	130lm	CREE	4°	
DSB2006-1	DC1500mA 1x6W	480lm	Luminus	6°	
DSB2010-1	DC700mA 1x10W	960lm	CREE	8°	
DSB2106-C	DC150mA 1x6W	414lm	HonourTEK	15°/24°/36°/50°	Triac/Dali/0-10V
DSB2110-C	DC250mA 1x10W	860lm	HonourTEK	15°/24°/36°/50°	Triac/Dali/0-10V
DSB2115-C	DC350mA 1x15W	1344lm	HonourTEK	15°/24°/36°/50°	Triac/Dali/0-10V
DSB2110-H	DC700mA 1x10W	860lm	TYANSHINE	15°/24°/36°/50°	

Size

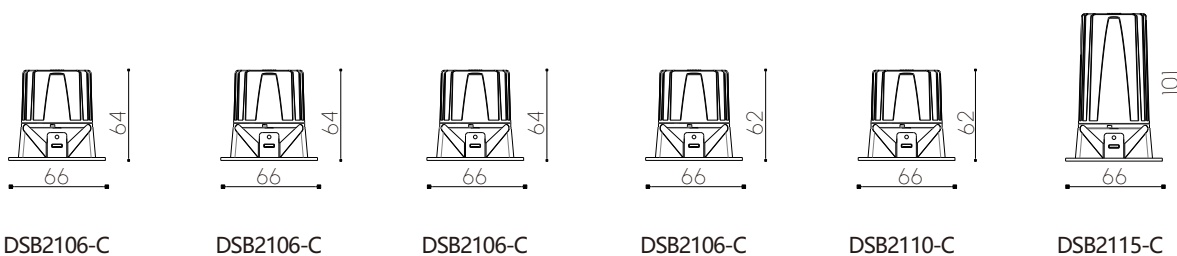



DSB2103-1

0.19 60x60 III V CE IP20

Material	Input	Luminous Flux	CRI	Lamp
Aluminum	DC700mA 1x3W	130lm/3000K	$R_a \geq 90$	CREE XPE

Color : White Black

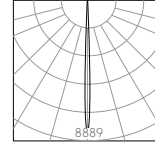
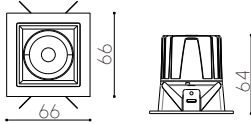

h(m)	E(lx)	D(m)
		4°
1	8200	0.07
2	2050	0.14
3	911	0.21
4	512	0.28

DSB2106-1

0.23 60x60 III V CE IP20



Material	Input	Luminous Flux	CRI	Lamp
Aluminum	DC1500mA 1x6W	480lm/3000K	$R_a \geq 90$	Luminus SST20

Color : White Black

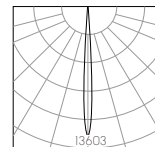
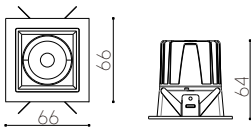

h(m)	E(lx)	D(m)
		6°
1	14000	0.1
2	3500	0.21
3	1550	0.32
4	875	0.42

Optional Colors for Baffle

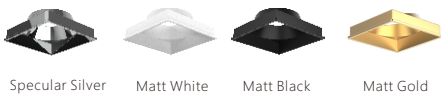

Specular Silver

Matt White

Matt Black

Matt Gold

Optional Accessories



Honeycomb
Size: $\phi 33 \times 3$

Combed Glass
Size: $\phi 33 \times 3$

Woven Glass
Size: $\phi 33 \times 3$



DSB2110-1

0.19 60x60 III V CE IP20

Material	Input	Luminous Flux	CRI	Lamp
Aluminum	DC700mA 1x10W	960lm/3000K	Ra≥90	XHP35

Color : White Black

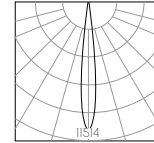
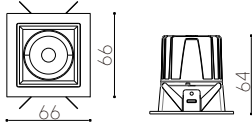

h(m)	E(lx)	D(m)
		8°
1	13600	0.14
2	3400	0.28
3	1510	0.42
4	850	0.56



DSB2106-C

0.19 60x60 III V CE IP20

Material	Input	Luminous Flux	CRI	Lamp
Aluminum	DC150mA 1x6W	414lm/3000K	Ra≥95	HonourTEK HRB0604

Color : White Black

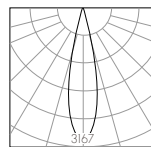
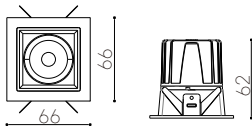

h(m)	E(lx)	D(m)
		15°
1	2236	0.33
2	559	0.66
3	248	0.99
4	139	1.32

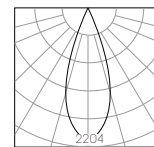

h(m)	E(lx)	D(m)
		24°
1	1532	0.46
2	383	0.92
3	170	1.38
4	95	1.84

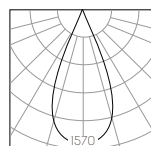

h(m)	E(lx)	D(m)
		36°
1	1068	0.62
2	267	1.24
3	120	1.86
4	67	2.50

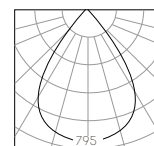

h(m)	E(lx)	D(m)
		50°
1	484	0.84
2	121	1.68
3	54	2.52
4	30	3.36

Optional Colors for Baffle



Specular Silver

Matt White

Matt Black

Matt Gold

Optional Accessories



Honeycomb
Size: ϕ 33x3

Combed Glass
Size: ϕ 33x3

Woven Glass
Size: ϕ 33x3



DSB2110-C

0.19 60x60 III V CE IP20

Material	Input	Luminous Flux	CRI	Lamp
Aluminum	DC250mA 1x10W	860lm/3000K	Ra ≥ 95	HonourTEK HRB0607

Color : White Black

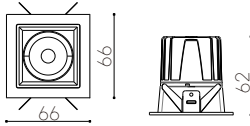

15°			24°		
h(m)	E(lx)	D(m)	h(m)	E(lx)	D(m)
1	3086	0.33	1	2284	0.46
2	772	0.66	2	570	0.92
3	343	0.99	3	254	1.38
4	193	1.32	4	143	1.84

36°			50°		
h(m)	E(lx)	D(m)	h(m)	E(lx)	D(m)
1	1116	0.60	1	758	0.84
2	379	1.24	2	190	1.68
3	168	1.86	3	84	2.52
4	95	2.40	4	47	3.36



DSB2115-C

0.23 60x60 III V CE IP20

Material	Input	Luminous Flux	CRI	Lamp
Aluminum	DC350mA 1x15W	1344lm/3000K	Ra ≥ 95	HonourTEK HRB0613

Color : White Black

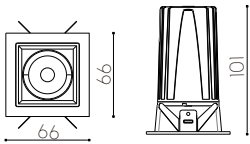

15°			24°		
h(m)	E(lx)	D(m)	h(m)	E(lx)	D(m)
1	5414	0.33	1	3601	0.46
2	1353	0.66	2	900	0.92
3	601	0.99	3	400	1.38
4	338	1.32	4	225	1.84

36°			50°		
h(m)	E(lx)	D(m)	h(m)	E(lx)	D(m)
1	2760	0.62	1	1053	0.84
2	690	1.24	2	263	1.68
3	307	1.86	3	117	2.52
4	172	2.50	4	66	3.36

Optional Colors for Baffle



Specular Silver

Matt White

Matt Black

Matt Gold

Optional Accessories



Honeycomb
Size: $\phi 33 \times 3$

Combed Glass
Size: $\phi 33 \times 3$

Woven Glass
Size: $\phi 33 \times 3$



DSB2110-H

Material	Input	Luminous Flux	CRI	Lamp
Aluminum	DC250mA lx10W	860lm/3000K	$R_a \geq 90$	TYANSHINE

2800k-6500k 2.4G 2-10W

Color : White Black

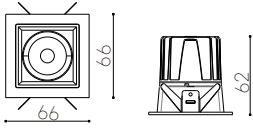

15°				24°			
h(m)	E(lx)	D(m)	4084	h(m)	E(lx)	D(m)	2878
1	2902	0.33		1	2059	0.46	
2	725	0.66		2	515	0.92	
3	322	0.99		3	230	1.38	
4	181	1.32		4	130	1.84	

36°				50°			
h(m)	E(lx)	D(m)	1302	h(m)	E(lx)	D(m)	499
1	1364	0.62		1	540	1.00	
2	341	1.24		2	135	2.00	
3	151	1.86		3	60	3.00	
4	85	2.50		4	34	4.00	

Optional Colors for Baffle



Specular Silver

Matt White

Matt Black

Matt Gold

Optional Accessories



Honeycomb
Size: $\phi 33 \times 3$

Combed Glass
Size: $\phi 33 \times 3$

Woven Glass
Size: $\phi 33 \times 3$

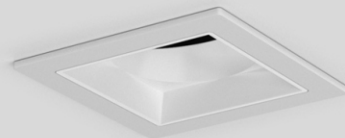
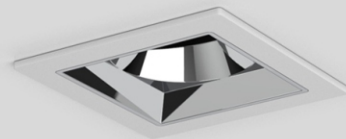
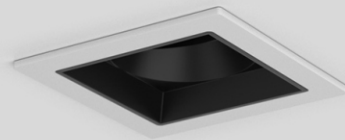
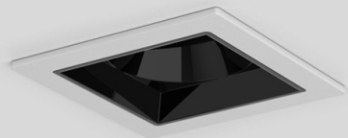
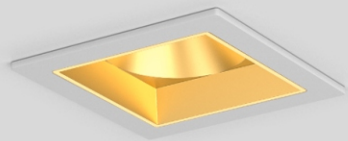

ARKLED Pty Ltd

Victoria Head office and Showroom

A 11/38 Down St Collingwood VIC 3066

T +61 (0)3 9015 4887

E sales@arkled.com.au

New South Wales Office

T +61 (0)2 8091 4478

E sales@arkled.com.au

Queensland, Western Australia, South Australia enquiries

T +61 402 553 524

E sales@arkled.com.au