

CORA
ROUND

ARKLED

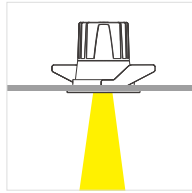

Fixed

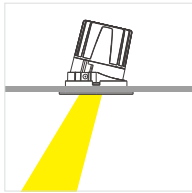

Adjustable

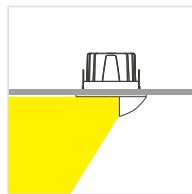

Wall Washer



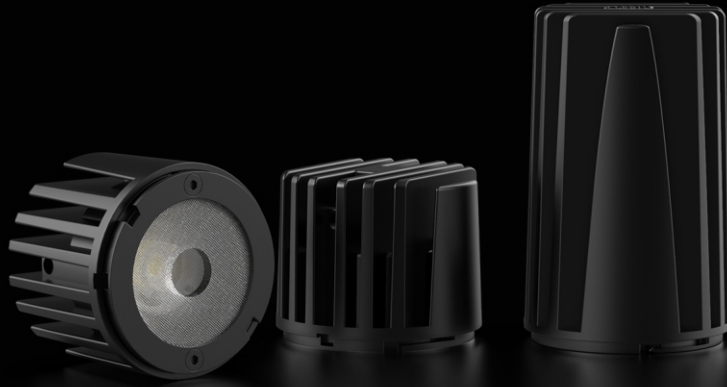

NO	ITEM CODE	POWER	INPUT	ANGLE	CRI	CCT	IP
MD03-1		3W	DC700mA 3V	4°	Ra≥90	2700K/3000K/ 3500K/4000K	IP20
MD06-1		6W	DC1500mA 3V	6°	Ra≥95	2700K/3000K/ 3500K/4000K	IP20
MD10-1		10W	DC700mA 12V	8°	Ra≥90	2700K/3000K/ 3500K/4000K	IP20
MD06-C		6W	DC150mA 36V	15°/24°/36°/50°	Ra≥95	2700K/3000K/ 3500K/4000K	IP20/IP54
MD10-C		10W	DC250mA 36V	15°/24°/36°/50°	Ra≥95	2700K/3000K/ 3500K/4000K	IP20/IP54
MD15-C		15W	DC350mA 36V	15°/24°/36°/50°	Ra≥95	2700K/3000K/ 3500K/4000K	IP20/IP54
MD10-H		2-10W Tunable White	DC250mA 36V	15°/24°/36°/50°	Ra≥90	2800K-6000K	IP20



MD10-H

Power: 2-10W
Input: 40-250mA
CCT: 2800K-6000K
Angle: 15°/24°/36°/50°

Dimmable Control

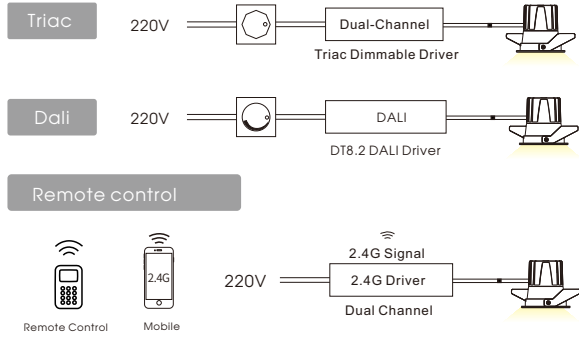

Low color temperature and low illumination



Low color temperature and high illumination



High color temperature and low illumination



High color temperature and high illumination

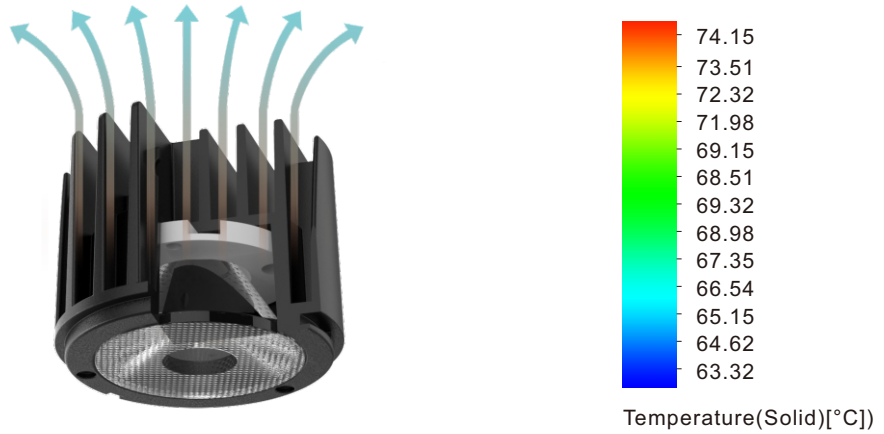

Thermal Management

The lifetime of LED is not only determined by its quality, but also affected by the thermal management. Especially for LED luminaires, only perfect thermal management can ensure the lifetime. If the heat cannot spread out quickly, the lifetime of LED will be seriously affected. The self-developed high-performance heatsink structure ensures that the LED light source can dissipate heat rapidly, and the chip temperature is lower than the working temperature defined by the light source manufacturer, which really guarantees the lifetime of LED.

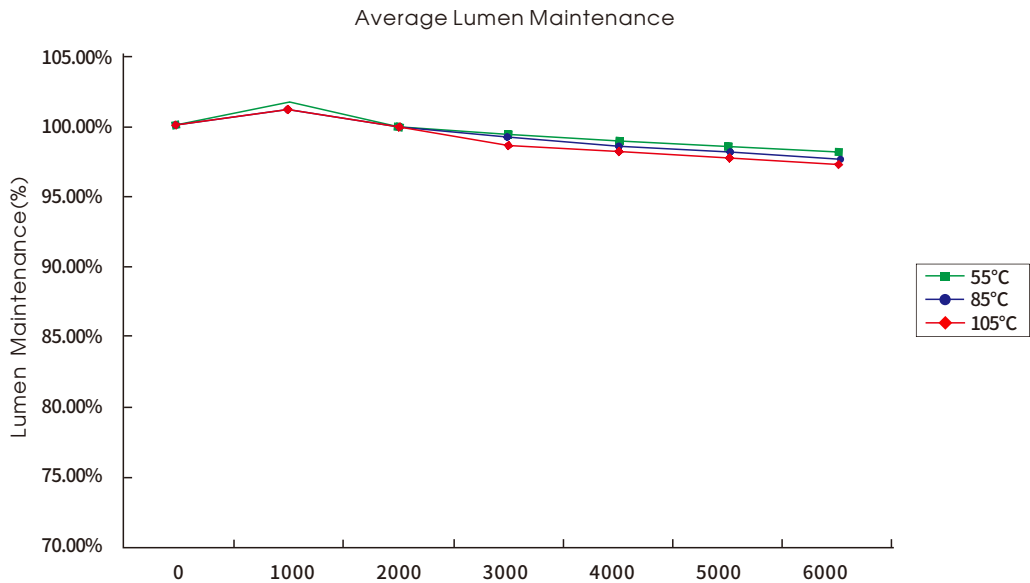

CRI COLOR METRICS(Values are typical)

COLOR Maintenance :
 ENERGY STAR LIMIT ≤ 0.007
 LM-80 6000hour Chromaticity Shift ($\Delta u'v'$) 0.0023

COB LED
 CRI>95



CRI95 TM-30 COLOR METRICS	
Rf	94
Rg	103
CCT	3000K
CIE Ra	97

R1	R2	R3	R4	R5	R6	R7	R8	R9	R10	R11	R12	R13	R14	R15
98	99	97	98	98	97	99	99	98	99	96	87	98	97	98



Ra80

Ra90

Ra95

CRI97 3000K COLOR RENDITION BY HUE ANGLE

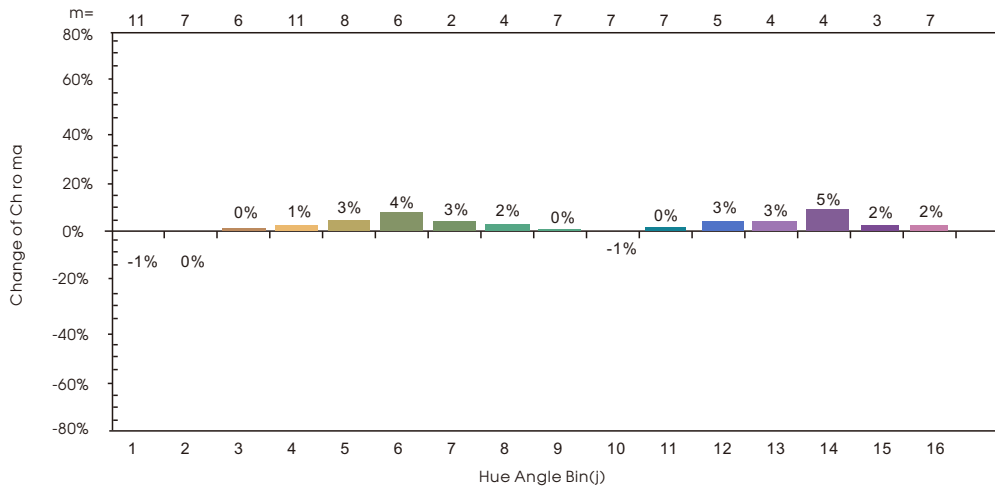

Radiate smooth spectrum from blackbody radiation curve, natural and mild, appropriate visual red effect. In addition, the standard series is also superior to the ceramic metal halide lamp and fluorescent lamp in terms of lighting quality, sustainability, efficiency and life, and superior to the competitors in terms of visual perception and consistency.



Optical Filters

Matching with different optical filters, not only can realize the angle change, but also can realize the facula shape change.

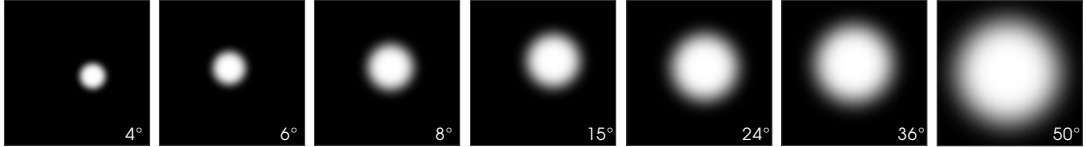

Optional Accessories



LED Module



LED Module + Woven Glass



Honeycomb



LED Module



LED Module+Combed Glass



Woven Glass

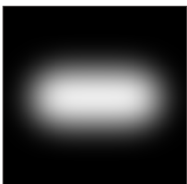

Combed Glass + LED Module = Effect

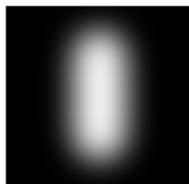

Combed Glass

UGR \leq 3.5

57 degree degree cut -off angle and concave LED module are used to be anti-glare and achieve uniform light

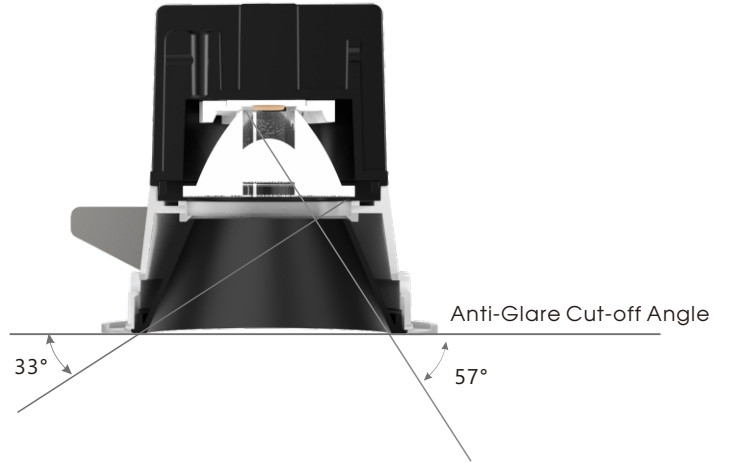

Optional Pin-hole Baffle



Optional Reflector Color



Specular Silver



Matt White











Matt Black



Matt Gold



Compatibility

	 Fixed Reflector	 Adjustable Reflector	 Pin Hole Reflector A	 Pin Hole Reflector B	 Anti-glare accessories
 SA Adjustable Frame		✓	✓	✓	✓
 SB Fixed Frame	✓		✓	✓	✓
 SS Universal Frame					✓

Cora recessed down light is featured with thousands of combination possibilities: 3W/6W/10W/15W LED module, fixed or adjustable, round or square, for direct lighting or wall washing. Cora are available in a choice of beam angles: super narrow 4°/6°/8°degrees for long distance light transmission, standard 15°/24°/36°/50°degrees, and special asymmetric wall washer lens for wall washing. With DARLIGHT design support, Cora provides a high level of comfortable visual and optimum light output ratio.



Product profile

Item Code	Input	Luminous Flux	Lamp	Beam Angle	Available Dimming
DSA2003-1	DC700mA 1x3W	130lm	CREE	4°	
DSA2006-1	DC150mA 1x6W	480lm	Luminus	6°	
DSA2010-1	DC700mA 1x10W	960lm	CREE	8°	
DSA2006-C	DC150mA 1x6W	414lm	HonourTEK	15°/24°/36°/50°	Triac/Dali/0-10V
DSA2010-C	DC250mA 1x10W	860lm	HonourTEK	15°/24°/36°/50°	Triac/Dali/0-10V
DSA2015-C	DC350mA 1x15W	1344lm	HonourTEK	15°/24°/36°/50°	Triac/Dali/0-10V
DSA2010-H	DC250mA 1x10W	860lm	TYANSHINE	15°/24°/36°/50°	

Size

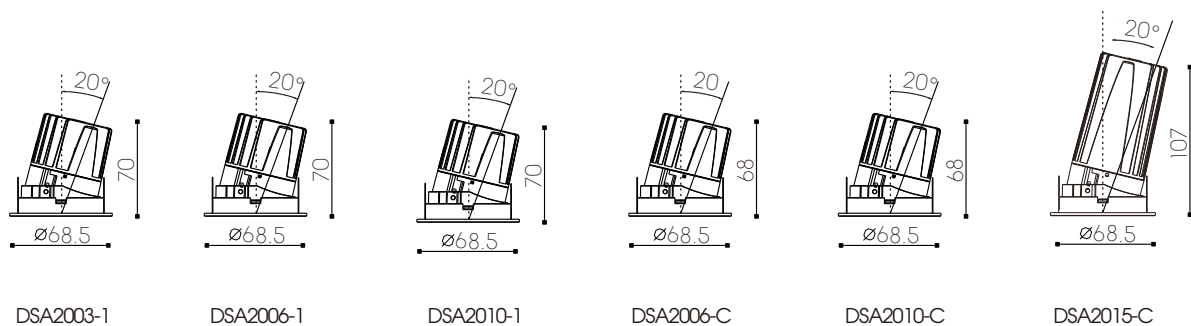

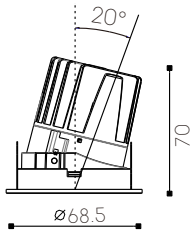

DSA2003-1

0.18 Ø62 III CE IP20

Material	Input	Luminous Flux	CRI	Lamp
Aluminum	DC700mA 1x3W	130lm/3000K	R _a ≥90	CREE XPE

Color: White Black

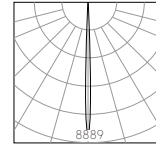

h(m)	E(lx)	D(m)
1	8200	0.07
2	2050	0.14
3	911	0.21
4	512	0.28

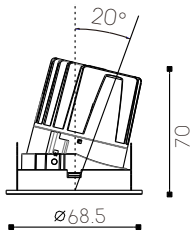

DSA2006-1

0.18 Ø62 III CE IP20

Material	Input	Luminous Flux	CRI	Lamp
Aluminum	DC150mA 1x6W	480Lm/3000K	R _a ≥90	Luminus SST20

Color: White Black

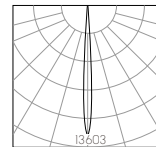

h(m)	E(lx)	D(m)
1	14000	0.1
2	3500	0.21
3	1550	0.32
4	875	0.42

Optional Accessories



Honeycomb
Size: Ø33×3



Combed Glass
Size: Ø33×3



Woven Glass
Size: Ø33×3

Optional Colors for Reflector



Specular Silver



Matt White



Matt Black



Matt Gold

Optional Baffle



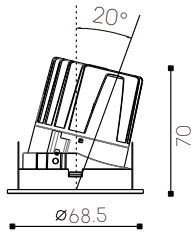

DSA2010-1

0.23 0.62 III CE IP20

Material	Input	Luminous Flux	CRI	Lamp
Aluminum	DC700mA 1x10W	960lm/3000K	Ra≥90	XHP35

Color : □ White ■ Black

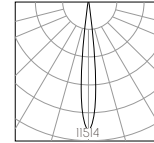

h(m)	E(lx)	D(m)
1	13600	0.14
2	3400	0.28
3	1510	0.42
4	850	0.56

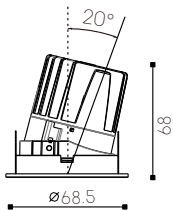

DSA2006-C

0.18 0.62 III CE IP20/IP54

Material	Input	Luminous Flux	CRI	Lamp
Aluminum	DC150mA 1x6W	414lm/3000K	Ra≥95	HonourTEK HRA0604

Color : □ White ■ Black

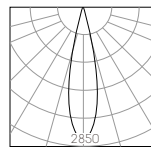

h(m)	E(lx)	D(m)
1	2042	0.33
2	510	0.66
3	227	0.99
4	128	1.32

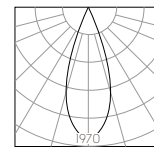

h(m)	E(lx)	D(m)
1	1386	0.46
2	347	0.92
3	154	1.38
4	87	1.84

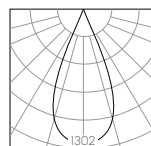

h(m)	E(lx)	D(m)
1	940	0.62
2	235	1.24
3	104	1.86
4	59	2.50

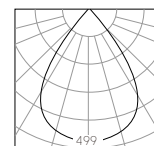

h(m)	E(lx)	D(m)
1	332	1.00
2	83	2.00
3	37	3.00
4	21	4.00

Optional Accessories



Honeycomb
Size: 33x3



Combed Glass
Size: 33x3



Woven Glass
Size: 33x3

Optional Colors for Reflector



Specular Silver



Matt White



Matt Black



Matt Gold

Optional Baffle



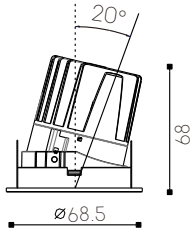

DSA2010-C

0.18 0.62 III V CE IP20/IP54

Material	Input	Luminous Flux	CRI	Lamp
Aluminum	DC250mA 1x10W	860lm/3000K	R _a ≥ 95	HonourTEK HRB0607

Color : □ White ■ Black

15°			24°		
h(m)	E(lx)	D(m)	h(m)	E(lx)	D(m)
1	2902	0.33	1	2059	0.46
2	725	0.66	2	515	0.92
3	322	0.99	3	230	1.38
4	181	1.32	4	130	1.84

36°			50°		
h(m)	E(lx)	D(m)	h(m)	E(lx)	D(m)
1	1364	0.62	1	540	1.00
2	341	1.24	2	135	2.00
3	151	1.86	3	60	3.00
4	85	2.50	4	34	4.00

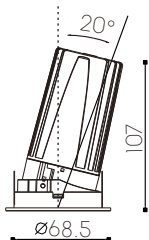

DSA2015-C

0.23 0.62 III V CE IP20/IP54

Material	Input	Luminous Flux	CRI	Lamp
Aluminum	DC350mA 1x15W	1344lm/3000K	R _a ≥ 95	HonourTEK HRB0613

Color : □ White ■ Black

15°			24°		
h(m)	E(lx)	D(m)	h(m)	E(lx)	D(m)
1	5142	0.33	1	2884	0.46
2	1285	0.66	2	720	0.92
3	571	0.99	3	320	1.38
4	321	1.32	4	180	1.84

36°			50°		
h(m)	E(lx)	D(m)	h(m)	E(lx)	D(m)
1	1974	0.62	1	332	1.00
2	493	1.24	2	83	2.00
3	219	1.86	3	37	3.00
4	123	2.50	4	21	4.00

Optional Accessories



Honeycomb
Size: Ø33×3



Combed Glass
Size: Ø33×3



Woven Glass
Size: Ø33×3

Optional Colors for Reflector



Specular Silver



Matt White



Matt Black



Matt Gold

Optional Baffle



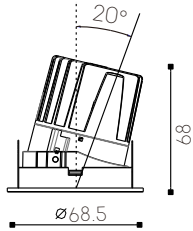

DSA2010-H

0.19 0.62 III F CE IP20

Material	Input	Luminous Flux	CRI	Lamp
Aluminum	DC250mA 1x10W	860lm/3000K	Ra ≥ 90	TYANSHINE

2800k-6500k 2.4G 2-10W

Color : White Black

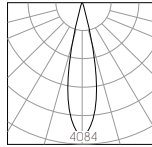

h(m)	E(lx)	D(m)
		15°
1	2902	0.33
2	725	0.66
3	322	0.99
4	181	1.32

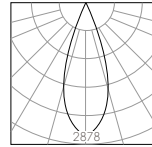

h(m)	E(lx)	D(m)
		24°
1	2059	0.46
2	515	0.92
3	230	1.38
4	130	1.84

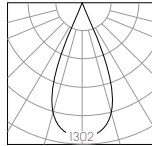

h(m)	E(lx)	D(m)
		36°
1	1364	0.62
2	341	1.24
3	151	1.86
4	85	2.50

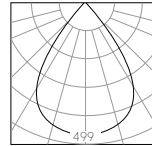

h(m)	E(lx)	D(m)
		50°
1	540	1.00
2	135	2.00
3	60	3.00
4	34	4.00

Optional Accessories



Honeycomb
Size: $\phi 33 \times 3$



Combed Glass
Size: $\phi 33 \times 3$



Woven Glass
Size: $\phi 33 \times 3$

Optional Colors for Reflector



Specular Silver



Matt White



Matt Black



Matt Gold

Optional Baffle



Cora recessed down light is featured with thousands of combination possibilities: 3W/6W/10W/15W LED module, fixed or adjustable, round or square, for direct lighting or wall washing. Cora are available in a choice of beam angles: super narrow 4°/6°/8°degrees for long distance light transmission, standard 15°/24°/36°/50°degrees, and special asymmetric wall washer lens for wall washing. With DARLIGHT design support, Cora provides a high level of comfortable visual and optimum light output ratio.



Product profile

Item Code	Input	Luminous Flux	Lamp	Beam Angle	Available Dimming
DSB2003-1	DC700mA 1x3W	130lm	CREE	4°	
DSB2006-1	DC150mA 1x6W	480lm	Luminus	6°	
DSB2010-1	DC700mA 1x10W	960lm	CREE	8°	
DSB2006-C	DC150mA 1x6W	414lm	HonourTEK	15°/24°/36°/50°	Triac/Dali/0-10V
DSB2010-C	DC250mA 1x10W	860lm	HonourTEK	15°/24°/36°/50°	Triac/Dali/0-10V
DSB2015-C	DC350mA 1x15W	1344lm	HonourTEK	15°/24°/36°/50°	Triac/Dali/0-10V
DSB2010-H	DC250mA 1x10W	860lm	TYANSHINE	15°/24°/36°/50°	

Size

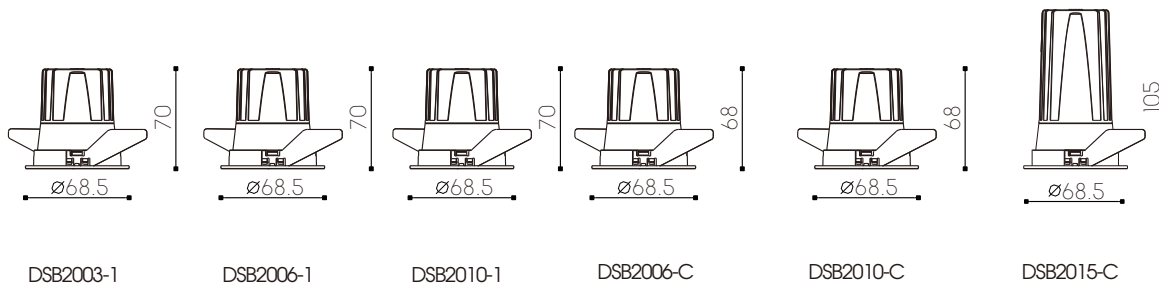

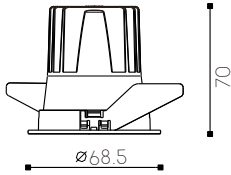

DSB2003-1

0.19 0.62 III V CE IP20

Material	Input	Luminous Flux	CRI	Lamp
Aluminum	DC700mA 1x3W	130lm/3000K	Ra \geq 90	CREE XP-E

Color : White Black

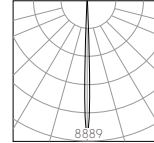

h(m)	E(lx)	D(m)
		4°
1	8200	0.07
2	2050	0.14
3	911	0.21
4	512	0.28

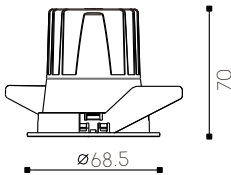

DSB2006-1

0.19 0.62 III V CE IP20

Material	Input	Luminous Flux	CRI	Lamp
Aluminum	DC150mA 1x6W	480lm/3000K	Ra \geq 90	Luminus SST20

Color : White Black

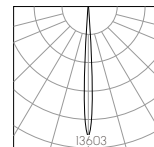

h(m)	E(lx)	D(m)
		6°
1	14000	0.1
2	3500	0.21
3	1550	0.32
4	875	0.42

Optional Accessories



Honeycomb
Size: ϕ 33x3



Combed Glass
Size: ϕ 33x3



Woven Glass
Size: ϕ 33x3

Optional Colors for Reflector



Specular Silver



Matt White



Matt Black



Matt Gold

Optional Baffle



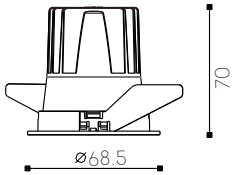

DSB2010-1

0.19 Ø62 III ∇ CE IP20

Material	Input	Luminous Flux	CRI	Lamp
Aluminum	DC700mA 1x10W	960lm/3000K	Ra≥90	XHP35

Color : White Black

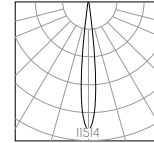

h(m)	E(lx)	D(m)
		8°
1	13600	0.14
2	3400	0.28
3	1510	0.42
4	850	0.56

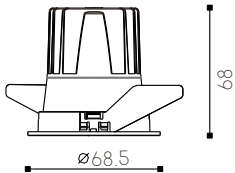

DSB2006-C

0.19 Ø62 III ∇ CE IP20/IP54

Material	Input	Luminous Flux	CRI	Lamp
Aluminum	DC150mA 1x6W	414lm/3000K	Ra≥95	HonourTEK HRA0604

Color : White Black

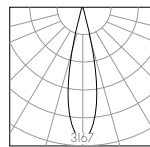

h(m)	E(lx)	D(m)
		15°
1	2236	0.33
2	559	0.66
3	248	0.99
4	139	1.32

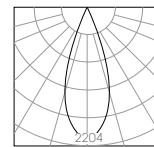

h(m)	E(lx)	D(m)
		24°
1	1532	0.46
2	383	0.92
3	170	1.38
4	95	1.84

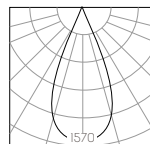

h(m)	E(lx)	D(m)
		36°
1	1068	0.62
2	267	1.24
3	120	1.86
4	67	2.50

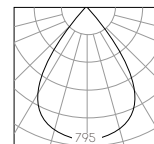

h(m)	E(lx)	D(m)
		50°
1	484	0.84
2	121	1.68
3	54	2.52
4	30	3.36

Optional Accessories



Honeycomb
Size: Ø33×3



Combed Glass
Size: Ø33×3



Woven Glass
Size: Ø33×3

Optional Colors for Reflector



Specular Silver



Matt White



Matt Black



Matt Gold

Optional Baffle



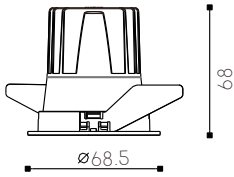

DSB2010-C

0.19 Ø62 III ∇ CE IP20/IP54

Material	Input	Luminous Flux	CRI	Lamp
Aluminum	DC250mA 1x10W	860lm/3000K	R _a ≥ 95	HonourTEK HRB0607

Color : □ White ■ Black

15°			24°		
h(m)	E(lx)	D(m)	h(m)	E(lx)	D(m)
1	3086	0.33	1	2284	0.46
2	772	0.66	2	570	0.92
3	343	0.99	3	254	1.38
4	193	1.32	4	143	1.84

36°			50°		
h(m)	E(lx)	D(m)	h(m)	E(lx)	D(m)
1	1116	0.60	1	758	0.84
2	379	1.24	2	190	1.68
3	168	1.86	3	84	2.52
4	95	2.40	4	47	3.36

DSB2015-C

0.23 Ø62 III ∇ CE IP20/IP54

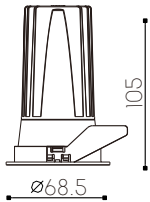

Material	Input	Luminous Flux	CRI	Lamp
Aluminum	DC350mA 1x15W	844lm/3000K	R _a ≥ 95	HonourTEK HRB0613

Color : □ White ■ Black

15°			24°		
h(m)	E(lx)	D(m)	h(m)	E(lx)	D(m)
1	5414	0.33	1	3601	0.46
2	1353	0.66	2	900	0.92
3	601	0.99	3	400	1.38
4	338	1.32	4	225	1.84

36°			50°		
h(m)	E(lx)	D(m)	h(m)	E(lx)	D(m)
1	2760	0.62	1	1053	0.84
2	690	1.24	2	263	1.68
3	307	1.86	3	117	2.52
4	172	2.50	4	66	3.36

Optional Accessories



Honeycomb
Size: Ø33×3



Combed Glass
Size: Ø33×3



Woven Glass
Size: Ø33×3

Optional Colors for Reflector



Specular Silver



Matt White



Matt Black



Matt Gold

Optional Baffle





DSB2010-H

Material	Input	Luminous Flux	CRI	Lamp
Aluminum	DC250mA lxIOW	590lm/3000K	Ra \geq 90	TYANSHINE

2800k-6500k 2.4G 2-10W

Color : White Black

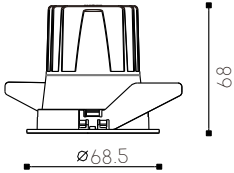

	h(m)	E(lx)	D(m)		h(m)	E(lx)	D(m)
			15°				24°
	1	2902	0.33		1	2059	0.46
	2	725	0.66		2	515	0.92
	3	322	0.99		3	230	1.38
	4	181	1.32	4	130	1.84	
			36°				50°
	1	1364	0.62		1	540	1.00
	2	341	1.24		2	135	2.00
	3	151	1.86		3	60	3.00
	4	85	2.50	4	34	4.00	

Optional Accessories



Honeycomb
Size: ϕ 33 \times 3



Combed Glass
Size: ϕ 33 \times 3



Woven Glass
Size: ϕ 33 \times 3

Optional Colors for Reflector



Specular Silver



Matt White



Matt Black



Matt Gold

Optional Baffle





ARKLED Pty Ltd

Victoria Head office and Showroom

A 11/38 Down St Collingwood VIC 3066

T +61 (0)3 9015 4887

E sales@arkled.com.au

New South Wales Office

T +61 (0)2 8091 4478

E sales@arkled.com.au

Queensland, Western Australia, South Australia enquiries

T +61 402 553 524

E sales@arkled.com.au